

**WATER FALL Schwallauslauf mit Einzelstrahlen für Wandmontage - Dark
Platinum gebürstet**













IMO

13 425 979



- Ausladung 22 mm
- PEARLSTREAM
- Platte 240 mm x 60 mm
- Anschluss 1/2" ablängbar
- Steckanschluss-Montage
- Durchfluss max. 9,5 l/min (bei 3 Bar)

Passt zu: IMO, LULU, MADISON, MEM,
TARA, CL.1, LISSÉ, VAIA, META, CYO

	Dark Platinum gebürstet	13 425 979-99
	Chrom	13 425 979-00
	Platin gebürstet	13 425 979-06
	Platin	13 425 979-08
	Dark Chrome	13 425 979-19
	Light Gold	13 425 979-26
	Light Gold gebürstet	13 425 979-27
	Messing gebürstet (23kt Gold)	13 425 979-28
	Schwarz matt	13 425 979-33
	Bronze gebürstet	13 425 979-42
	Champagne gebürstet (22kt Gold)	13 425 979-46
	Champagne (22kt Gold)	13 425 979-47
	Chrom gebürstet	13 425 979-93

Empfohlenes Zubehör



UP-Wandwinkel -

- Max. Einbautiefe 163 mm
- Min. Einbautiefe 90 mm

35 085 970 90

Empfohlenes Zubehör



UP-Wandwinkel -

- Max. Einbautiefe 163 mm
- Min. Einbautiefe 90 mm

35 085 970 90

13 425 979
mm [inches]

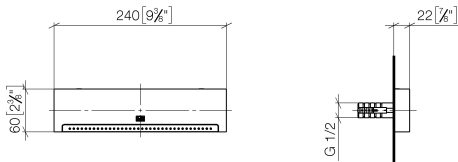

Durchflussdiagramm

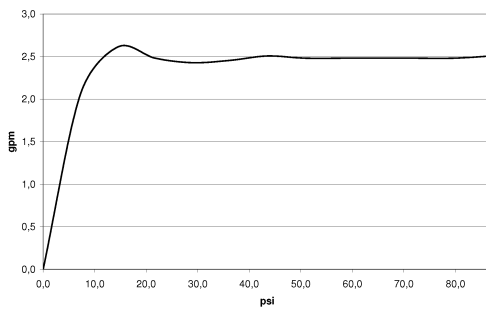

Wurfweitendiagramm

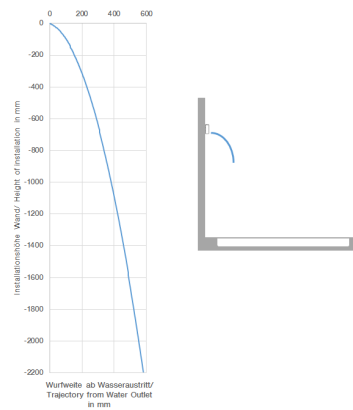

Zertifikate

LGA_19935.

IAPMO_4976 (4).

13 425 979

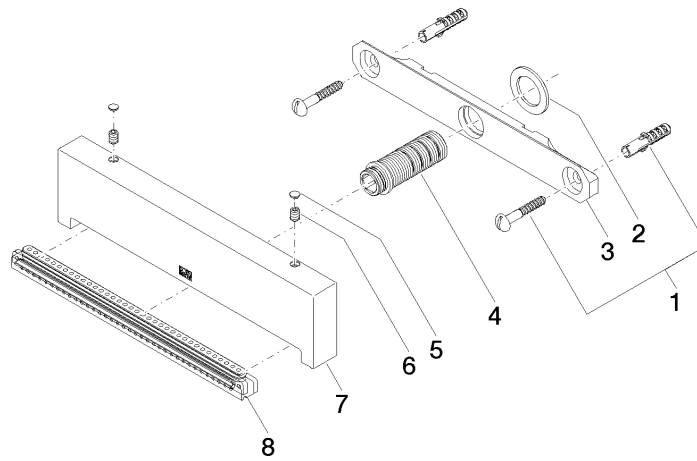

Ersatzteilstückliste

Nr.	Artikelnummer	Benennung	Verbaumenge	Lieferzeit
1	04 30 31 024 01 90	Befestigungssatz	1	2
2	09 14 05 009 90	Dichtung	1	2
3	09 17 97 053 90	Halter	1	2
4	90 24 03 199 00 90	Anschluss	1	2
5	90 31 20 087 00-99	Stopfen	1	30
6	09 31 11 144 90	Stift	2	2
7	09 17 01 185 20-99	Auslauf	1	30
8	90 29 03 071 00 90	Einsatz	1	2